

.....

FA701CKP
FA701CVKP

TouchCenter Keypads

**Installation and
Set-Up Guide**

.....



K6248-2V1 6/07 Rev. A

Table of Contents

.....

SECTION 1 – General Information	1-1
About the TouchCenter.....	1-1
System Features	1-1
Security	1-1
Setup	1-1
Compatibility	1-2
ECP Error	1-2
SECTION 2 – Mounting and Wiring.....	2-1
Mounting the TouchCenter Mounting Plate.....	2-1
Wiring the TouchCenter	2-2
SECTION 3 – Front Panel LEDs and Navigation Icons.....	3-1
Front Panel LEDs.....	3-1
Navigation Icons	3-2
SECTION 4 – Initial Setup.....	4-1
Programming the Control Panel.....	4-1
FA701CVKP Word List	4-2
TouchCenter Initialization	4-3
Power Up.....	4-3
How to Change the ECP Address	4-3
How to Access the Central Station Screen	4-4
How to Select System Options.....	4-7
How to Set the NIGHT Setup Button Function	4-8
How to View and Edit Screen Security	4-9
How to View Code Authority.....	4-10
How to View the Panel Configuration.....	4-11
TouchCenter Setup	4-12
How to Adjust the TouchCenter Contrast.....	4-13
How to Adjust the Volume.....	4-14
How to Select Screen Backlight Off Activation Time.....	4-15
How to Select Homepage After Time	4-16
How to Set the Time and Date	4-18
Setting Operating Modes	4-23
SECTION 5 – User Codes	5-1
Introduction to User Code Setup	5-1
Authority Levels	5-1
How to Access User Setup	5-2
How to Add a User	5-4

How to Delete a User.....	5-6
How to Edit a User.....	5-7
SECTION 6 – Maintenance.....	6-1
About TouchCenter Maintenance.....	6-1
How to Clean the TouchCenter.....	6-1
Routine Care.....	6-3
SECTION 7 – Troubleshooting.....	7-1
Troubleshooting.....	7-1
Panel Fault Displays.....	7-1
Diagnostics.....	7-2
About Diagnostics.....	7-2
How to Access the Diagnostics.....	7-2
Performing Diagnostics.....	7-4
LCD Display Test.....	7-4
Audio Test.....	7-5
LED Test.....	7-6
SECTION 8 – Safe Mode.....	8-1
About the Safe Mode.....	8-1
Entering the Safe Mode.....	8-1
Automatic Entry.....	8-1
Manual Entry.....	8-2
Operating in the Safe Mode.....	8-2
Exiting the Safe Mode.....	8-2
SECTION 9 – Specifications.....	9-2
Specifications.....	9-2
SECTION 10 – Index.....	10-2

Conventions Used in This Manual



Before you begin using this manual, it is important that you understand the meaning of the following symbols (icons) and text note.

UL These notes include specific information that must be followed if you are installing this system for a UL Listed application.

 These notes include information that you should be aware of before continuing with the installation, and which, if not observed, could result in operational difficulties.

Note: These text notes are provided throughout the manual to provide informative information and shortcut tips for the installer.

General Information

In This Section

- ◆ *About the TouchCenter*
- ◆ *Compatibility*
- ◆ *System Features*
- ◆ *ECP Error*

About the TouchCenter

The FA701CKP and FA701CVKP are intuitive, graphical touch-screen keypads that combine security and home control. They can be used for:

- Quick and easy security system operation
- Control of the home environment, including lights and contains provisions for the future control of heating and air-conditioning.

UL The home environment control feature has not been evaluated by UL.

System Features

Security

- Arm System
 - Away
 - Stay
 - Night
- Disarm System
- User Codes - Allows authorized user to add or delete codes
- Bypass Zones

Setup

- Volume
- Contrast
- Diagnostics
- Keypad Emulation (Console Mode)

Compatibility

The below listing identifies the alarm systems that the TouchCenter can interface with, the maximum number of TouchCenters that can be used with each system, and the minimum alarm panel software revision level for compatibility.

<u>ALARM SYSTEM</u>	<u>MAXIMUM NUMBER OF TOUCHCENTERS</u>	<u>MINIMUM SOFTWARE REVISION LEVEL</u>
FA148CP	2	3.0
FA168CPS	2	All Levels
FA168CPS	4	5.0
FA1660C	3	2.4
FA1700C	1	1.5
FA1700C	3	2.0



- On all panels except the residential panels, you may obtain the software revision level of the alarm panel by entering the program mode and then entering **#92** on the keypad. The second line of the keypad displays the software revision level (without the decimal point).
 - The keypad sound suppression feature available in some commercial panels is not compatible with the TouchCenter.
-

ECP Error

The message “ECP Error” will be displayed at the top of the screen (except for the Home screen) when the TouchCenter cannot communicate with the alarm panel. This may be caused by an incorrect ECP address in the TouchCenter or because AUI type devices have not been enabled in the panel. While this message is being displayed, you must use the TouchCenter default code of “4140” any time the TouchCenter requests an authorized code.

Mounting and Wiring

.....

In This Section

- ◆ *Mounting the TouchCenter Mounting Plate*
 - ◆ *Wiring the TouchCenter*
-

Mounting the TouchCenter Mounting Plate

The TouchCenter should be mounted using the following criteria:

- The TouchCenter must be mounted **indoors**,
- should be mounted at eye level for easy viewing by the user, and
- should not be mounted in areas of high condensation such as bathrooms.

To mount the TouchCenter mounting plate, complete the following steps:

1. Detach the mounting plate from the TouchCenter by pushing it toward the bottom of the TouchCenter.
2. Locate the mounting plate over the mounting surface such that the opening in the mounting plate is aligned with the wire/cable access opening (in the mounting surface) while passing the wires/cable through the opening in the mounting plate. (See Figure 1.)
Note: The back of the TouchCenter has wire channels leading to the bottom and the left side if surface wiring is being used.
3. Secure the mounting plate to the mounting surface using four screws (supplied).

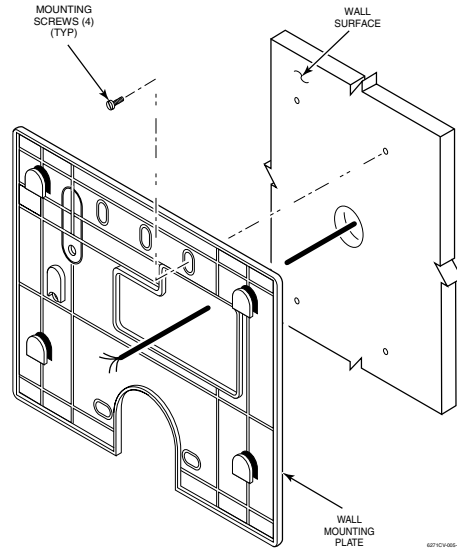

Figure 1. Mounting the TouchCenter Mounting Plate

Wiring the TouchCenter

Connect TouchCenter in parallel with keypads and other peripheral devices using the keypad data (ECP) bus. Determine wire gauge by referring to the Wire Run Length/Gauge table below.

Wire Run Length/Gauge Table	
Wire Gauge	Length
#22 gauge	115 feet
#20 gauge	175 feet
#18 gauge	300 feet
#16 gauge	450 feet

If more than one keypad is wired to one run, then the above maximum lengths must be divided by the number of keypads on the run (e.g., the maximum length is 57 feet if two keypads are wired on a #22 gauge run).



Unshielded 4-conductor cable is recommended for the power/data wire.

SECTION 2: Mounting and Wiring

To wire, see the Summary of Connections diagrams at the back of this guide, or the appropriate Systems Interconnection Diagram provided, and follow the instructions below.



The TouchCenter draws up to 230mA. If you are planning to power it from your panel's Aux Power output, check your panel's Installation and Setup Guide and verify that this device and others do not exceed your panel's Aux Power output capability. If it does, a supplementary power supply is needed.

Connect the wires to the TouchCenter terminal block as follows:

1. Connect +12VDC to the TouchCenter using step a or b below.
 - a. If powering the keypad from the control panel, connect the AUX + terminal of the control panel to the + terminal block (+12VDC terminal of the TouchCenter (red wire)).
 - b. If powering the keypad from a supplementary power supply, connect the + terminal of the supplementary power supply to the + terminal block (+12VDC terminal of the TouchCenter (red wire)).

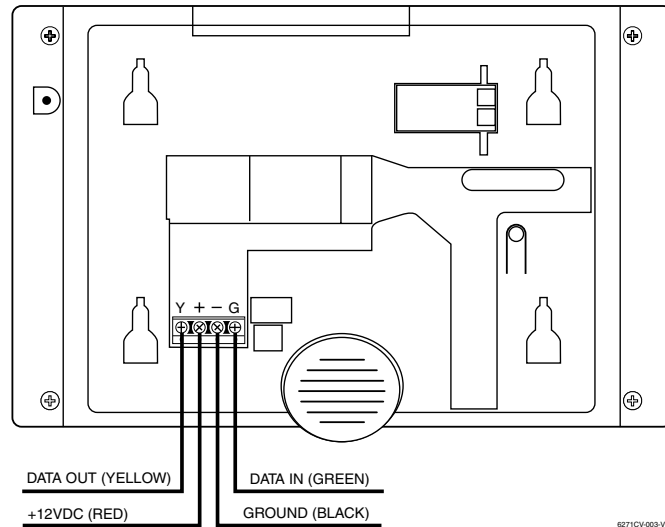

Figure 2. Wiring the TouchCenter

2. Connect ground to the TouchCenter using step a or b below.
 - a. If powering the keypad from the control panel, connect the AUX – terminal of the control panel to the – terminal block position (GND terminal of the TouchCenter (black wire)).
 - b. If powering the keypad from a supplementary power supply, connect the AUX – terminal of the control panel to the (–) terminal of the supplementary power supply (black wire). Then, connect the (–) terminal of the supplementary power supply to the – terminal block position (GND terminal of the TouchCenter (black wire)).
3. Connect Data Out terminal of the control panel to the Y terminal block position (Data In terminal of the TouchCenter (yellow wire)).
4. Connect the Data In terminal of the control panel to the G terminal block position (Data Out terminal of the TouchCenter (green wire)).
5. Mount the TouchCenter onto the mounting plate as shown in Figure 3.

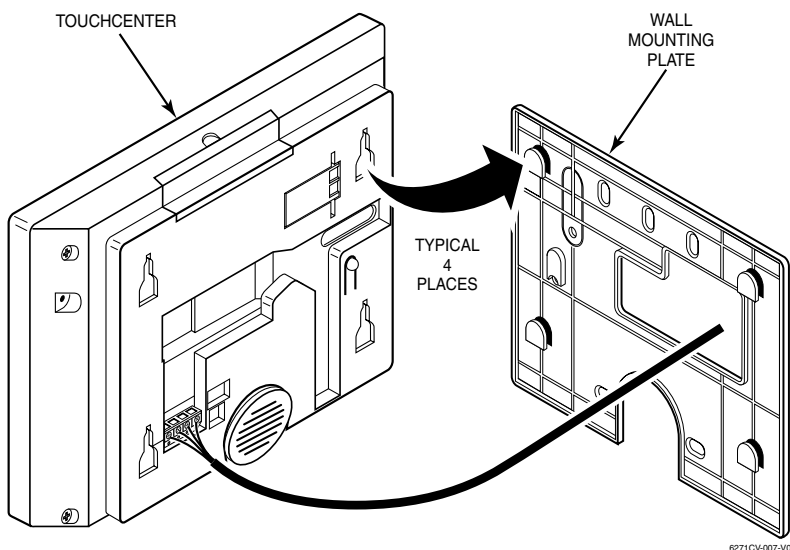

Figure 3. Mounting the TouchCenter

Front Panel LEDs and Navigation Icons

In This Section

- ◆ *Front Panel LEDs*
- ◆ *Navigation Icons*





Front Panel LEDs

The TouchCenter has three LEDs labeled - ARMED, READY and TROUBLE (FA701CKP) or MESSAGE (FA701CVKP). The ARMED LED is red, READY LED is green and TROUBLE or MESSAGE LED is yellow. Each LED's on and off state has different meanings as described below.

LED	DESCRIPTION
ARMED	ON – Security system is armed. OFF – Security system is not armed.
READY	ON – Security system is disarmed and ready to arm. OFF – Security system is armed or disarmed but not ready. If disarmed, faults or troubles are present.
MESSAGE (FA701CVKP)	FLASHING – The FA701CVKP contains new message(s) for the User OFF – No new messages.
TROUBLE (FA701CKP)	ON – The Security System has one or more Trouble(s). OFF – No Trouble.

Navigation Icons

To aid in the navigation through TouchCenter screens, a set of user-friendly icons has been provided. The appearance, function, and location of these icons is described below:

ICON	LOCATION	FUNCTION
	"Home" screen	Allows you to record and retrieve voice messages. (FA701CVKP Only)
	"Home" screen	Allows you to turn certain devices on and off (if installed and programmed by your installer.)
	"Home" screen	Accesses "Arming" screen. Note: The lock symbol and lock color in the button indicates security system status. Unlocked and green – system disarmed Unlocked and yellow – system disarmed and a system trouble exists Locked and red – system armed
	Upper left corner of most screens	Returns you to the TouchCenter "Home" screen. This icon is called the Home button within the text of this document.
	Upper right corner of most screens	Reverts to the last screen viewed. This icon is called the Back button within the text of this document.
	Lower right corner of screen	Displays Emergency functions (as programmed by the installer). This icon is called the Panic button within the text of this document. Note: This icon is displayed and active on all screens except while in the Clean Screen mode and during an LCD Display test in Diagnostics.

Initial Setup

.....

In This Section

- ◆ *Programming the Control Panel*
 - ◆ *TouchCenter Initialization*
 - ◆ *How to Change the ECP Address*
 - ◆ *How to Access the Central Station Screen*
 - ◆ *TouchCenter Setup*
 - ◆ *Setting Chime Mode On / Off*
-

Programming the Control Panel

The TouchCenter will not be fully operational unless its address in the control panel has been enabled for an alpha console, AUI type device, and assigned to a partition (where applicable). Refer to “Compatibility” on page 1–2 of this document for the quantity of TouchCenters that may be used and the required control panel software revision level.

Note: When programming your control panel, if you change the zone types for your emergency zones you may disable the emergency buttons in the TouchCenter. The emergency buttons in the TouchCenter are active for zone types 06 and 07 (Panic button), 08 (Medical button), and 09 (Fire button). Additionally, the Medical button is also compatible with a zone type 15 (24-Hour Medical) for panels that contain this zone type.

On residential control panels (FA148CP, FA168CPS, or equivalent), up to four TouchCenters may be used (addresses 1, 2, 5 and 6). Addresses 1 and 2 (in field *189) are enabled by default. If the defaults have been changed, enable these addresses (in field *189) using an alpha-keypad and the Data Field Programming procedures located in the panel Installation and Setup Guide.

On commercial control panels (FA1660C, FA1700C, or equivalent), addresses 1, 2, and from 3 through 30 may be used for the TouchCenter. These addresses in the control panel are normally not defaulted for AUI type devices. To enable the addresses you will be using for TouchCenters, use an alpha-keypad and follow the

procedures for “Device Programming” in your control panel “Programming Guide.”

Notes:

- If multiple TouchCenters are being used, they must be set to addresses 1, 2, and X (where X equals any address from 3 through 30. Only one AUI type device may be assigned to an address from 3 through 30 on commercial control panels.
- The TouchCenter should not be assigned as a Master Console. If the TouchCenter is assigned as a Master Console, partitions must be controlled from the Partition screen or using the Console Emulation Mode.

FA701CVKP Word List

The FA701CVKP has the capability of enunciating the words listed below. Please note that this listing does not increase the vocabulary available from your panel. You must use the listing in your alarm panel instructions for actual words that may be requested for enunciation.

AC-Loss	Down	Glass	Office	South
Air	Downstairs	Gun	On	Station
Alarm	Driveway	Hall	One	Stay
Apartment	Duct	Heat	One-Hundred	Storage
Area	East	House	Open	Supervise
Armed	Eight-Hundred	Hundred	Outside	Telco
Attic	Eight	Inside	Panic	Temperature
Away	Eighteen	Instant	Patio	Ten
Baby	Eighty	Kitchen	Phone	Third
Back	Eleven	Laundry	Police	Thirteen
Bar	Emergency	Left	Pool	Thirty
Basement	Equipment	Library	Power	Three-Hundred
Bathroom	Exit	Light	Ready-to-Arm	Three
Bed	Factory	Living	Rear	Tool
Bedroom	Father's	Loading	Right	Twelve
Blower	Fault	Low-Battery	Room	Twenty
Boiler	Fence	Lower	Second	Two-Hundred
Building	Fifteen	Machine	Service	Two
Bypassed	Fifty	Main	Seven-Hundred	Up
Call	Fire	Master	Seven	Upper
Carbon-Monoxide	First	Medical	Seventeen	Upstairs
Central	Five-Hundred	Mother's	Seventy	Utility
Check	Five	Motion	Shed	West
Closed	Floor	Night	Shop	Window
Computer	Forty	Nine-Hundred	Side	Wing
Daughter's	Four-Hundred	Nine	Six-Hundred	Yard
Den	Four	Nineteen	Six	Zero
Detector	Fourteen	Ninety	Sixteen	Zone
Dining	Foyer	North	Sixty	
Disarmed	Front	Not	Sliding	
Disarm-System-Now	Garage	Now	Smoke	
Door	Gas	Off	Son's	

TouchCenter Initialization

Power Up

When initially powered, the screen displays the boot sequence as it is performed. After it is determined what services are available, the screen displays the Set ECP Address screen.

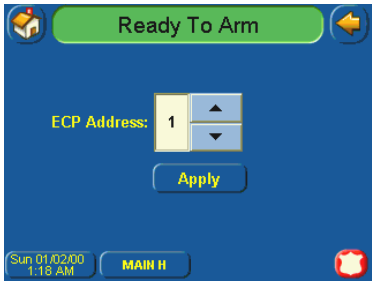
SCREEN	ACTION
	<p>If the system is incorporating only one TouchCenter, leave the address set to 1 and press the APPLY button. The boot-up process will continue until completion.</p> <p>If there are to be additional TouchCenter units in the system, refer to the <i>How to Change the ECP Address</i> paragraph.</p>



How to Change the ECP Address

After enabling addresses in the control panel using an alpha-keypad, power up each TouchCenter one at a time, and set its address to one of the addresses you enabled in the control panel. If this is a first time power-up of the unit, follow the initialization procedure in this section. Otherwise, access the Central Station screen then follow the procedure to change the address on the unit.

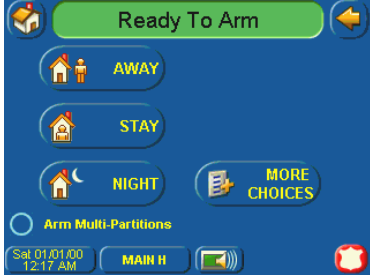

How to Access the Central Station Screen

To Access the “Central Station” screen perform the following:

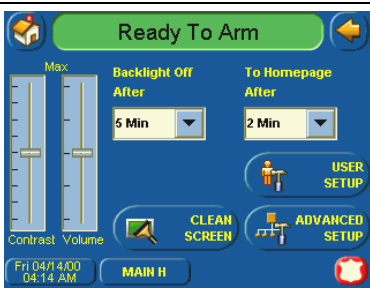
1. Press the **SECURITY** button on the “Home” screen. The “Arming” screen is displayed.

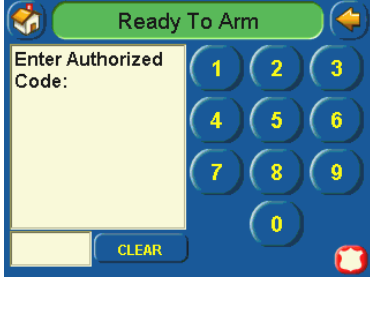

SCREEN	ACTION
	<ol style="list-style-type: none"> 2. Press the MORE CHOICES button. The “More Choices” screen is displayed.
	<ol style="list-style-type: none"> 3. Press the SETUP button on the “More Choices” screen. The “Setup” screen is displayed.
	<ol style="list-style-type: none"> 4. Press the ADVANCED SETUP button. The Enter Authorized Code: authorization screen is displayed.

SECTION 4: Initial Setup

SCREEN	ACTION
 <p>The screenshot shows a blue interface with a green header 'Ready To Arm' and a back arrow. Below the header is a yellow box labeled 'Enter Authorized Code:' followed by a numeric keypad (0-9) and a 'CLEAR' button. A red shield icon is in the bottom right corner.</p>	<p>5. Enter your 4-digit Installer code. The “Advanced Setup” menu screen is displayed.</p> <p>Note: If the top of the screen is displaying ECP Error, the ECP address in the TouchCenter is not valid for the panel that it is connected to. To change the ECP address in the TouchCenter when ECP Error is being displayed, enter the TouchCenter default code of “4140” to advance to the next screen.</p>
 <p>The screenshot shows a blue interface with a green header 'Ready To Arm' and a back arrow. Below the header are several menu options: 'CENTRAL STATION', 'KEYPAD TEST', 'KEYPAD RESET', and 'Software Version' (0.0.4 - July 20, 2005). At the bottom, it shows 'Sun 01_02_00 1:27 AM' and a 'MAIN H' button. A red shield icon is in the bottom right corner.</p>	<p>6. Press the Central Station button. The “Central Station” menu screen is displayed.</p>
 <p>The screenshot shows a blue interface with a green header 'Ready To Arm' and a back arrow. Below the header are several menu options: 'ECP Address', 'Screen Security', 'Options', 'Night Setup', 'Device Events', 'Code Authority', 'Resets = 232', and 'Running 0:00:04:53'. At the bottom, it shows 'Sun 01_02_00 1:28 AM' and a 'MAIN H' button. A red shield icon is in the bottom right corner.</p>	<p>NOTE: The Resets and Running counters are shown on this screen near the lower-left corner. The Resets counter displays the number of times the TouchCenter has been reset since it was installed while the Running counter indicates how long the TouchCenter has been running since the last time it was reset.</p>



TouchCenter Installation and Setup Guide

To change the address, perform the following.

SCREEN	ACTION
	<p>1. On the "Central Station" screen press the ECP Address button. A pop-up window is displayed with options for selecting the TouchCenter's ECP address.</p>
	<p>2. The available ECP addresses are: 1-2, 5-6 for residential controls or 1-30 for commercial controls</p> <p>Select the ECP address for this TouchCenter using the Up/Dn arrows. Press the APPLY button to accept the address setting or the BACK or HOME buttons to maintain the original ECP address. If APPLY is selected, the TouchCenter will reset. If BACK is selected, The "Central Station" menu screen is displayed.</p>
	

How to Select System Options

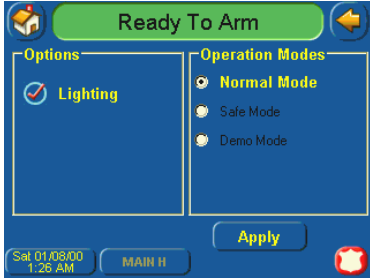
The system options allow you to place buttons on the "Home" screen. The **SECURITY** button is always displayed and cannot be removed. A Lighting button can also be added to the "Home" screen. To avoid confusion to the user, only buttons whose options are functional in the system should be displayed. To select the system options, do the following:



SCREEN	ACTION
	<p>1. On the "Central Station" screen press the Options button. A pop-up window is displayed with an option for selecting Lighting.</p>
	<p>2. Touch the Lighting button to turn the Lighting option on or off. A checkmark appears in the button when the Lighting option is "ON".</p> <p>Note: DO NOT select the Demo Mode option. This option should only be selected if instructed to do so by factory service. When this option is selected, the keypad will not communicate with the control panel and any user can select Advanced Setup screens.</p> <p>Press the Apply button to accept the setting. The TouchCenter returns to the "Central Station" menu screen.</p>
	

How to Set the NIGHT Setup Button Function

The NIGHT button can be set to arm the system in one of four arming modes:

- Away - When selected, arms all zones with entry delay.
- Stay - When selected, arms perimeter zones with entry delay.
- Instant - When selected, arms perimeter zones without entry delay.
- Night (Residential Panels Only) – When selected, arms all perimeter zones plus all zones listed in Zone List 5.
- Maximum - When selected, arms all zones without entry delay.

To set the NIGHT button function, do the following:

SCREEN	ACTION
	<p>1. On the "Central Station" screen press the Night Setup button. A Night Setup: pop-up window is displayed with options for selecting Away, Stay, Instant, Maximum and Night.</p>
	<p>2. Select the arming mode that will be activated by pressing the NIGHT button on the "Arming" screen. Press the Apply button to accept the setting, or press the Back button to cancel your selection. In either case the TouchCenter goes to the "Central Station" menu screen.</p>

SECTION 4: Initial Setup

SCREEN	ACTION
	

How to View and Edit Screen Security

The **Screen Security** button displays a screen that lists the various screen classes in the TouchCenter and lists what level user has been given access to them. To view and/or edit screen security, do the following:

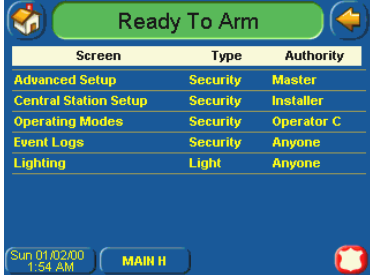
SCREEN	ACTION																		
	<p>1. On the “Central Station” screen, press the Screen Security button. A listing of the classes of screens and the user level that has access to them will be displayed.</p>																		
 <table border="1" data-bbox="393 1339 747 1472"> <thead> <tr> <th>Screen</th> <th>Type</th> <th>Authority</th> </tr> </thead> <tbody> <tr> <td>Advanced Setup</td> <td>Security</td> <td>Master</td> </tr> <tr> <td>Central Station Setup</td> <td>Security</td> <td>Installer</td> </tr> <tr> <td>Operating Modes</td> <td>Security</td> <td>Operator C</td> </tr> <tr> <td>Event Logs</td> <td>Security</td> <td>Anyone</td> </tr> <tr> <td>Lighting</td> <td>Light</td> <td>Anyone</td> </tr> </tbody> </table>	Screen	Type	Authority	Advanced Setup	Security	Master	Central Station Setup	Security	Installer	Operating Modes	Security	Operator C	Event Logs	Security	Anyone	Lighting	Light	Anyone	<p>2. If the listing is correct, depress the BACK button to return to the “Central Station” screen. If changes are necessary, select the line to be changed and a Setup screen will be displayed.</p> <p>Note: The Setup screen contains a heading of Advanced Setup, Central Station Setup, Operating Modes, Event Logs, or Lighting indicating which line was selected for change.</p>
Screen	Type	Authority																	
Advanced Setup	Security	Master																	
Central Station Setup	Security	Installer																	
Operating Modes	Security	Operator C																	
Event Logs	Security	Anyone																	
Lighting	Light	Anyone																	

SCREEN	ACTION
	<p>3. Select the level of user who is to have access to the selected class of screens and then select the OK button. The Screen Security screen will be re-displayed listing the change. Depress the BACK button to return to the “Central Station” screen.</p> <p>Note: The User Levels listed on this screen match the Users Levels in commercial panels. See the chart below for corresponding User Levels in Residential Panels.</p>

Residential Panels and Screen Security

Authority Level in Panel	Matching Authority Level in TouchCenter	Access Level Chosen in TouchCenter Screen Security					
		Installer	Master	Manager	Operator A	Operator B	Operator C
System Master	Master	No	Yes	Yes	Yes	Yes	Yes
Partition Master	Master	No	Yes	Yes	Yes	Yes	Yes
Standard User	Normal	No	No	No	Yes	Yes	Yes
Arm Only	N/A	No	No	No	No	No	No
Guest	Guest	No	No	No	No	Yes	Yes
Duress	N/A	No	No	No	No	No	No

How to View Code Authority

The **Code Authority** button displays a screen that contains the User Name and Partition Authority Level for the User Code that is entered. To view the Code Authority level, do the following:

SCREEN	ACTION
	<p>1. On the “Central Station” screen press the Code Authority button. An Enter Authorized Code screen will be displayed.</p>

SECTION 4: Initial Setup

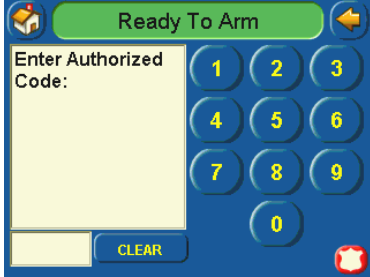
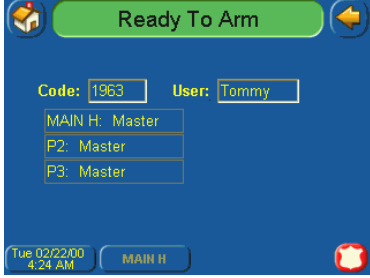
SCREEN	ACTION												
	<p>2. Enter the 4-digit User Code corresponding to the user that you want to obtain Authority Level information about. An Authority Level screen containing this information will be displayed.</p>												
	<p>3. Press the BACK button to return to the “Central Station Screen”.</p> <p>Note: The User Levels listed on this screen match the Users Levels in commercial panels. See the chart below for corresponding User Levels in Residential Panels.</p> <p>Authority In Panel Level Shown As</p> <table border="0"> <tr> <td>Standard User</td> <td>Operator A</td> </tr> <tr> <td>Arm Only</td> <td>Unknown</td> </tr> <tr> <td>Guest</td> <td>Operator B</td> </tr> <tr> <td>Duress</td> <td>Duress</td> </tr> <tr> <td>Partition Master</td> <td>Master</td> </tr> <tr> <td>System Master</td> <td>Master</td> </tr> </table>	Standard User	Operator A	Arm Only	Unknown	Guest	Operator B	Duress	Duress	Partition Master	Master	System Master	Master
Standard User	Operator A												
Arm Only	Unknown												
Guest	Operator B												
Duress	Duress												
Partition Master	Master												
System Master	Master												

How to View the Panel Configuration

The **Panel Config** button displays a screen that contains the configuration of the panel that the TouchCenter is connected to. To view the panel configuration, do the following:

SCREEN	ACTION
	<p>1. On the “Central Station” screen press the Panel Config button. A Panel Configuration screen will be displayed providing details of your system.</p>

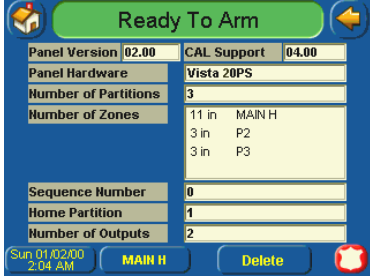
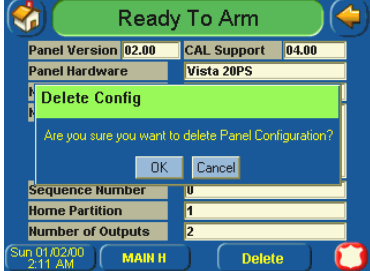
SCREEN	ACTION
	<p>2. Depress the Back button to return to the “Central Station” screen or if you desire to clear the configuration from the TouchCenter and have it reload the panel configuration into the TouchCenter from the panel, depress the Delete button. After you depress the Delete button, a confirmation screen is displayed.</p>
	<p>3. Select OK to delete the configuration or Cancel to return to the “Panel Configuration” screen. If you select OK, the TouchCenter will be reset and the panel configuration will be downloaded from the panel into the TouchCenter. After the reset and download is complete, the “Home” screen is displayed.</p>

TouchCenter Setup

Setup allows you to make changes to the way your TouchCenter is operating. The options that can be changed are:



- Adjust the touch screen contrast
- Adjust the TouchCenter sounder volume
- Change the time interval that must pass prior to the TouchCenter turning off the touch screen backlight
- Change the time interval that must pass prior to the TouchCenter returning to the “Home” screen

Additionally, you may enter the **User Setup** screen, **Advanced Setup** screen (if enabled by your system installer), or **Clean Screen** (maintenance mode) from the "Setup" screen by pressing the corresponding button.

Access the "Setup" screen as follows:

1. From the "Home" screen, press the **SECURITY** button. The "Arming" screen is displayed.

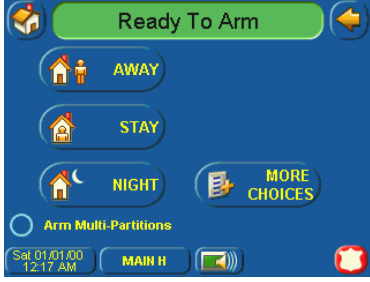
SECTION 4: Initial Setup

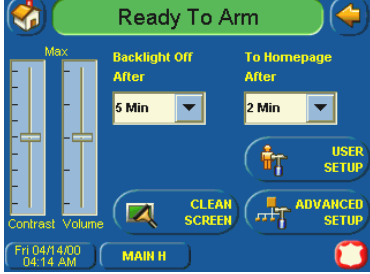
SCREEN	ACTION
	<p>2. Press the MORE CHOICES button. The "More Choices" screen is displayed.</p>
	<p>3. Press the SETUP button on the "More Choices" screen. The "Setup" screen is displayed.</p>
	<p>4. Adjust the TouchCenter options as described in the paragraphs that follow.</p>

How to Adjust the TouchCenter Contrast

You may adjust the TouchCenter contrast as follows:

If...	Then...
you want to increase contrast	move the slide bar above the current contrast setting.
you want to decrease contrast	move the slide bar below the current contrast setting.

If you have made any changes in the contrast settings, when you exit this screen you will be presented with a pop-up asking if you want to remember the new settings.

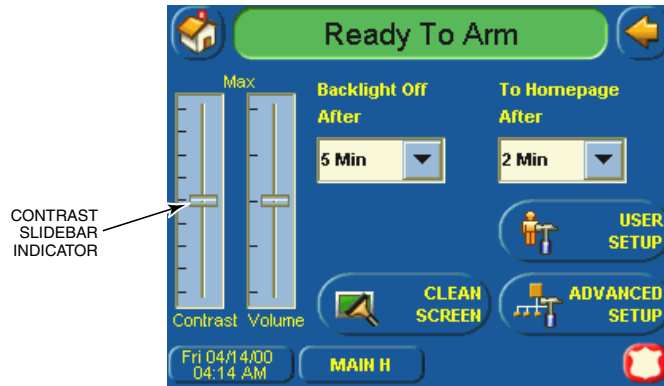

TouchCenter Contrast Control

How to Adjust the Volume

You may adjust the TouchCenter sounder volume by pressing your finger on the TouchCenter slide bar associated with the "Volume" scale and doing the following:

If...	Then...
you want to increase volume	move the slide bar above the current volume setting.
you want to decrease volume	move the slide bar below the current volume setting.

If you have made any changes in the volume settings, when you exit this screen you will be presented with a pop-up asking if you want to remember the new settings.



Volume Control

How to Select Screen Backlight Off Activation Time

When the TouchCenter is not active, it will automatically turn the backlight off after the selected backlight off time has expired (unless “Never” option is selected). To select the screen backlight time, do the following:

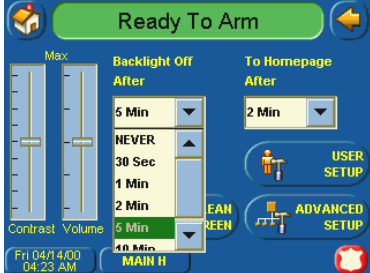
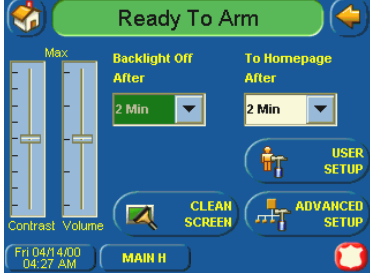
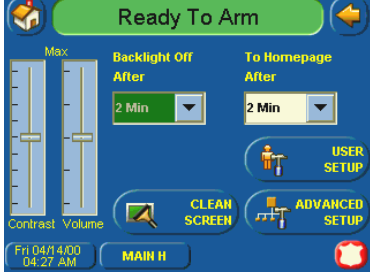

SCREEN	ACTION
	<p>1. On the "Setup" screen, press the Backlight Off After: "arrow" button. A drop-down list displaying the time period options is displayed.</p>

SCREEN	ACTION
	<p>2. Select the time period option you want by pressing it. The drop-down list closes automatically and the selection is displayed.</p> <p>Note: Additional options can be viewed by using the up/down "arrows" to scroll through the time period options.</p>
	<p>3. Press either the "Home" or "Back" button. A Settings Changed! pop-up window is displayed asking "Remember New Settings?" Select Yes to save the change or No to discard the change.</p>
	<p>When the Update is complete the TouchCenter goes to the "Home" screen or "More Choices" screen depending on whether you pressed the "Home" or "Back" button, respectively.</p>

How to Select Homepage After Time

When the TouchCenter is not active, it will automatically return to the "Home" screen after the selected To Homepage After time has expired (unless "Never" option is selected). To select the To Homepage After time, do the following:

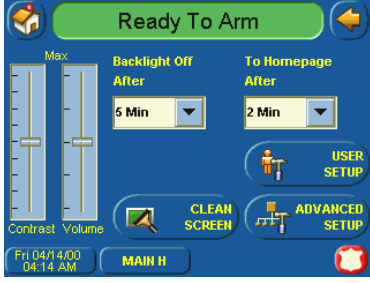
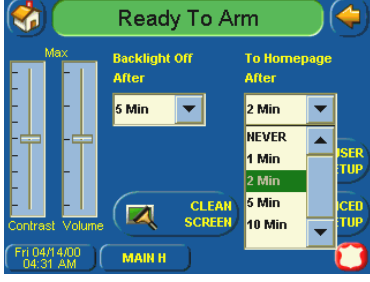
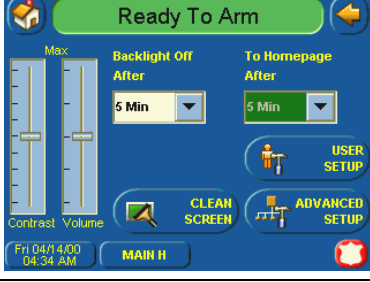
SECTION 4: Initial Setup



SCREEN	ACTION
	<p>1. On the "Setup" screen, press the To Homepage After "arrow" button. A drop-down list displaying the time period options is displayed.</p>
	<p>2. Select the time period option you want by pressing it. The drop-down list closes automatically and the selection is displayed.</p>
	<p>3. Press either the "Home" or "Back" button. A Settings Changed! pop-up window is displayed asking "Remember New Settings?" Select Yes to save the change or No to discard the change.</p>
	<p>When the Update is complete the TouchCenter goes to the "Home" screen or "More Choices" screen depending on whether you pressed the "Home" or "Back" button, respectively.</p>

How to Set the Time and Date

You can set the time and date from the **Set Time & Date** screen. Pressing the Time and Date button located at the bottom of the TouchCenter screen displays the **Set Time & Date** screen.

- When the time is set it will be stored in the TouchCenter and sent to the control panel when you press the **Apply** button and answer **Yes** to the following prompt. Additionally, when using the TouchCenter with a residential panel, the panel will download its time into the TouchCenter once an hour after the clock is set.
- If **Get Time** is pressed, the TouchCenter will download the time and date from the control panel and exit the Set Time & Date screen. **Note:** This button appears with residential panels only.
- If **DST On** (Daylight Savings Time) is selected, the TouchCenter will adjust for Daylight Savings time at the month, week and time chosen.

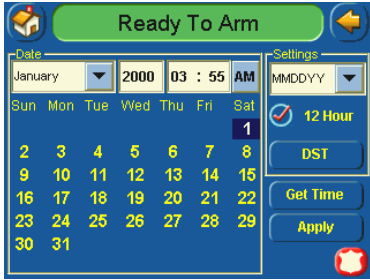
To set the time and date, press the Time and Date button located at the bottom of the screen and do the following:

SCREEN	ACTION
	<p>1. On the "Time and Date" screen, press the Month/Day/Year "arrow" button in the "Settings" area of the screen. A drop-down list displaying the Month/Day/Year display formats is displayed.</p>
	<p>2. Select the display format you want by pressing it. The drop-down list closes automatically and the selection is displayed.</p>

SECTION 4: Initial Setup

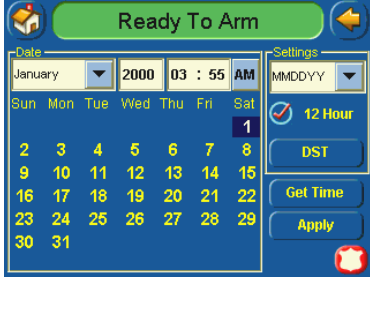
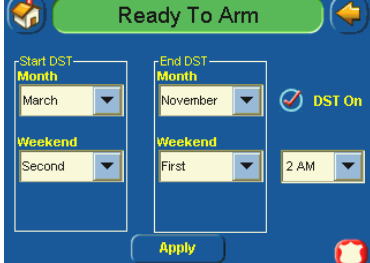
SCREEN	ACTION
	<p>3. Select if you want a 12-hour or 24-hour format for your time display by touching the circle to the left of the 12 Hour display in the "Settings" area of the screen. A check mark in the circle indicates a 12-hour display format.</p> <p>4. Select if you want Daylight Savings Time to affect your system clock by pressing the DST button in the "Settings" area of the screen. The Daylight Savings Screen will be displayed.</p>
	<p>5. Select if you want Daylight Savings Time to affect your system clock by touching the circle to the left of the DST On display. A check mark in the circle indicates that Daylight Savings Time is applicable.</p> <p>6. On the "Daylight Savings" screen, press the Month "arrow" button in the "Start DST" area of the screen. A drop-down list displaying the Months is displayed.</p> <p>7. Select the month you want by pressing it. The drop-down list closes automatically and the selection is displayed.</p> <p>8. On the "Daylight Savings" screen, press the Weekend "arrow" button in the "Start DST" area of the screen. A drop-down list displaying the weeks is displayed.</p> <p>9. Select the week you want by pressing it. The drop-down list closes automatically and the selection is displayed.</p> <p>10. On the "Daylight Savings" screen, press the Month "arrow" button in the "End DST" area of the screen. A drop-down list displaying the Months is displayed.</p> <p>11. Select the month you want by pressing it. The drop-down list closes automatically and the selection is displayed.</p>

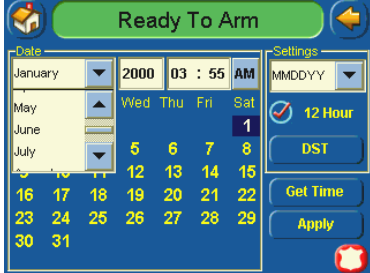
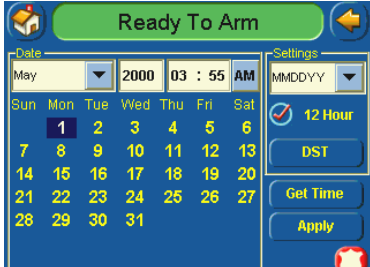
SCREEN	ACTION
	<p>12. On the "Daylight Savings" screen, press the Weekend "arrow" button in the "End DST" area of the screen. A drop-down list displaying the weeks is displayed.</p> <p>13. Select the week you want by pressing it. The drop-down list closes automatically and the selection is displayed.</p> <p>14. On the "Daylight Savings" screen, press the "arrow" button to the right of the time (1 AM or 2 AM) on the screen. A drop-down list displaying 1 AM and 2AM is displayed.</p> <p>15. Select the time you want by pressing it. The drop-down list closes automatically and the selection is displayed.</p> <p>16. Press the APPLY button to save your Daylight Savings Time setup. The "Time and Date screen is displayed.</p> <p>17. On the "Time and Date" screen, press the Month "arrow" button. A drop-down list displaying the months is displayed.</p>
	<p>18. Select the current month by pressing it. The drop-down list closes automatically and the selection is displayed.</p>
	<p>19. On the "Time and Date" screen, press the Year that is being displayed. A Year screen is displayed with the instructions to Enter 4 digits for the year.</p>

SECTION 4: Initial Setup

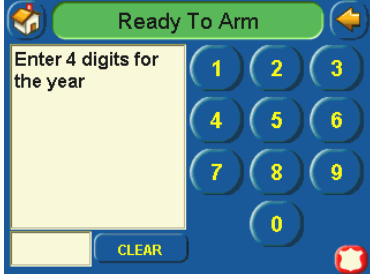
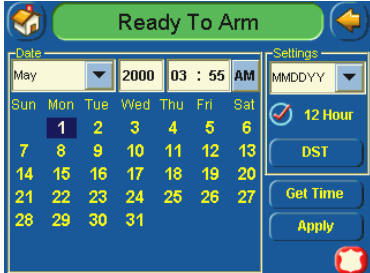
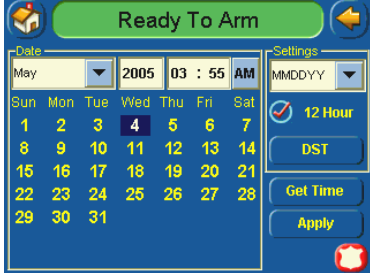
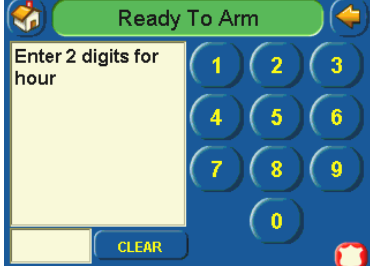
SCREEN	ACTION
	<p>20. Enter the four digits for the current year. The window closes automatically and the selection is displayed.</p>
	<p>21. Select if it is AM or PM by pressing on the AM or PM display on the screen. Each depression switches the AM/PM display.</p> <p>22. Select the day of the month by touching the proper day in the display. The selected date will be highlighted on the screen.</p>
	<p>23. On the "Time and Date" screen, press the Hour that is being displayed. An hour screen is displayed with the instructions to Enter 2 digits for the hour.</p>
	<p>24. Enter the two digits for the current hour. The window closes automatically and the selection is displayed.</p>

TouchCenter Installation and Setup Guide

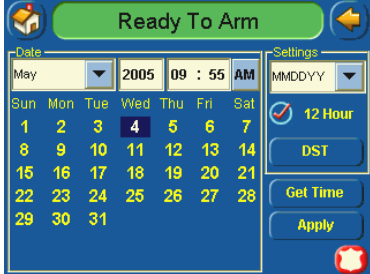
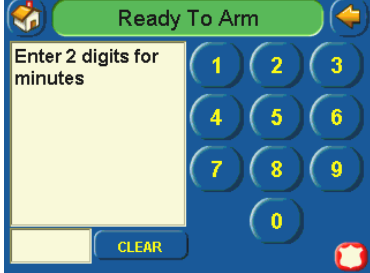
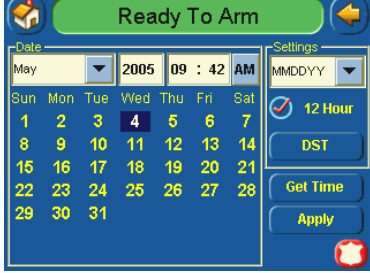
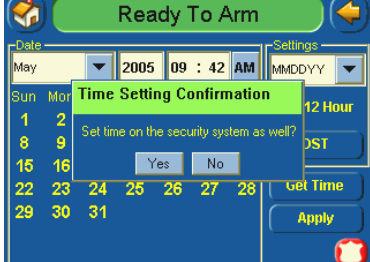
SCREEN	ACTION
	<p>25. On the "Time and Date" screen, press the Minutes that is being displayed. A minutes screen is displayed with the instructions to Enter 2 digits for the minutes.</p>
	<p>26. Enter the two digits for the current minute. The window closes automatically and the selection is displayed.</p>
	<p>27. On the "Time and Date" screen, press the Apply button. A confirmation screen is displayed.</p>
	<p>28. Press the Yes button to save the time changes in your security system or press the No button to have the changes affect the TouchCenter only. Note: A Yes response is recommended.</p>



Setting Operating Modes

Operating modes allow you to turn the TouchCenter chime mode on or off. Additionally, when using the FA701CVKP you may also turn the voice mode on or off. The operating modes provide the following features:

- Chime Mode – When selected, a request is sent to the alarm panel requesting that the panel chime the TouchCenter whenever a change in zone status occurs.
- Voice Mode (FA701CVKP Only) – When selected, a request is sent to the alarm panel requesting that the panel initiate TouchCenter voice enunciation whenever a change in system status occurs such as Armed, Disarmed, or Alarms.
- Voice Chime Mode (FA701CVKP Only) – The chime mode and voice mode are in effect. When selected, you will get the chime beeps followed by voice enunciation.

Access the "Operating Modes" screen as follows:

1. From the "Home" screen, press the **SECURITY** button. The "Arming" screen is displayed.

SCREEN	ACTION
	<ol style="list-style-type: none"> 2. Press the MORE CHOICES button. The "More Choices" screen is displayed.
	<ol style="list-style-type: none"> 3. Press the OPERATING MODES button on the "More Choices" screen. The "User Authorization" screen is displayed with the instructions "Enter Authorized Code".

TouchCenter Installation and Setup Guide

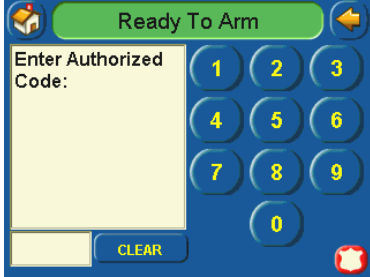
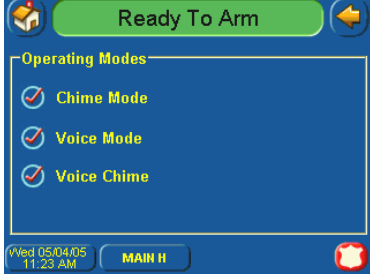
SCREEN	ACTION
	<p>4. Enter your Authorized code. The "Operating Modes" screen is displayed.</p>
	<p>5. Touch the Chime Mode button to turn the Chime Mode on or off. A checkmark appears in the button when the Chime Mode is "ON". Note that it may take a few seconds for the Chime Mode to take effect.</p> <p>6. (FA701CVKP Only) Touch the Voice Mode button to turn the Voice Mode on or off. A checkmark appears in the button with the Voice Mode is "ON" Note that if the Chime Mode and Voice Mode are both selected, the Voice Chime button will automatically be selected.</p> <p>Press the "HOME" or "BACK" button after making your selection. When the TouchCenter exits the "Operating Modes" screen, your selection is saved.</p>

User Codes

In This Section

- ◆ *Introduction to User Code Setup*
- ◆ *How to Access User Setup*
- ◆ *Authority Levels*

Introduction to User Code Setup

Each user must be assigned a name with a corresponding 4-digit user code in order to gain access to various features and functions. The TouchCenter can hold the identity for 10 Users in its memory. If additional Users are needed, define the additional Users using the Console Emulation Mode.

Users for the system are programmed in a central user setup location that provides the specific questions for authorization levels assigned to different users. You may want these users to be the same, but there are situations in which you may want a user to have limited capabilities. These capabilities are defined by the Authority Level assigned to each user.

Authority Levels

Authority levels define the system functions a particular user can perform. Depending on the authority assigned to you, there are certain system functions you may be prohibited from performing. The following information describes the authority levels available in the TouchCenter and provides the equivalent authority level name that you will find if you are reading your alarm system manuals. The authority levels available in the TouchCenter are as follows:





Touch-Center Authority Level	Functions	Equivalent System Name	
		Residential Systems	Commercial Systems
Installer	Can perform all security functions except can only disarm if code was used to arm, can change Master Code, cannot change other user codes, can access the Central Station Screen options Note: This authority level can not be assigned using the TouchCenter	Installer	Installer
Master	Can perform all security functions, add/delete users in assigned partition, program scheduled events, and change partition master code	Partition Master	Level 1 Master
Normal	Perform security functions (arm, disarm)	Standard User	Level 3 Operator A
Guest	Can arm the system in assigned partitions, but cannot disarm the system unless the system was armed with this code. Note: Do not assign this level if Quick Arm is enabled in the system.	Guest	Level 4 Operator B
No Access	Used to restrict access from a partition.	N/A	N/A

How to Access User Setup

Access User Setup as follows:

1. From the "Home" screen, press the **SECURITY** button. The "Arming" screen is displayed.

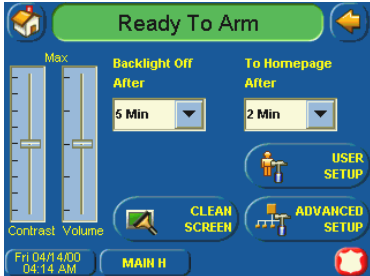
SECTION 5: User Codes

SCREEN	ACTION
	<p>2. Press the MORE CHOICES button on the “Arming” Screen. The “More Choices” screen is displayed.</p>
	<p>3. Press the SETUP button on the “More Choices” screen. The “Setup” screen is displayed.</p>
	<p>4. Press the USER SETUP button on the “Setup” screen. The User Setup screen is displayed.</p>
	

How to Add a User

Add a User as follows:

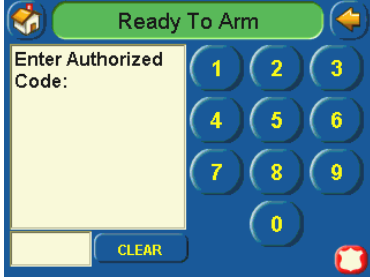
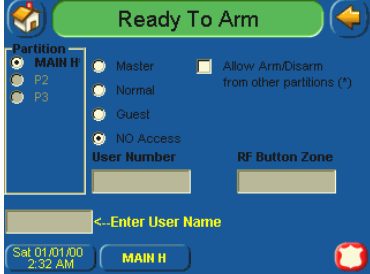
SCREEN	ACTION
	<p>1. To add a user, press the ADD USER button. The "User Authorization" screen is displayed with the instructions "Enter Authorized Code".</p>
	<p>2. Enter your Authorized code. The "User Options" screen is displayed.</p> <p>Note: The authorized code for adding users is dependent upon the alarm panel you are interfacing with. Check your alarm panel Installation and Setup Guide to determine who can add users.</p>
	<p>3. Press the box next to Enter User Name. The Enter Data keyboard screen is displayed.</p>

SECTION 5: User Codes

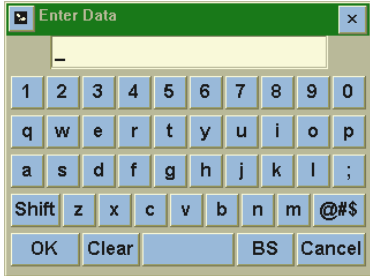
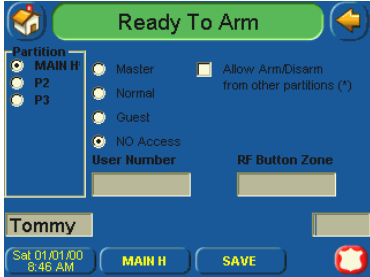
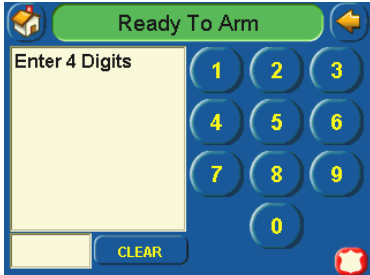
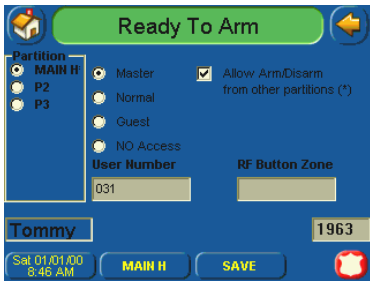
SCREEN	ACTION
 <p>The screenshot shows a window titled "Enter Data" with a close button (x). Below the title bar is a text input field containing a single underscore character. Below the input field is a numeric keypad with digits 1-0. Below the numeric keypad is a QWERTY keyboard layout. At the bottom of the screen are buttons for "OK", "Clear", "BS" (Backspace), and "Cancel".</p>	<p>4. Type in the user name (6 characters max.) and press the OK button. The "User Options" screen is displayed with Enter User Code... displayed.</p> <p>Notes:</p> <ul style="list-style-type: none"> • Use the Shift button for capital letters. • Use the BS (Backspace) button to make corrections. • The @#\$ button is not available for use at this time. These characters cannot be saved to the control panel.
 <p>The screenshot shows the "Ready To Arm" screen. On the left, there are radio buttons for "Partition" selection: "MAIN H" (selected), "P2", and "P3". To the right, there are radio buttons for access level: "Master", "Normal", "Guest", and "NO Access". A checkbox labeled "Allow Arm/Disarm from other partitions (*)" is checked. Below these options are two input fields: "User Number" and "RF Button Zone". At the bottom, the name "Tommy" is displayed in a box, along with the date and time "Sat 01/01/00 8:46 AM" and buttons for "MAIN H", "SAVE", and a red alarm icon.</p>	<p>5. Touch the box next to Enter User Code... The "User Authorization" screen is displayed with the instructions "Enter 4 Digits".</p>
 <p>The screenshot shows the "Ready To Arm" screen with a numeric keypad for entering 4 digits. The keypad has buttons for digits 1-0 and a "CLEAR" button. The name "Tommy" is visible at the bottom left, and the date and time "Sat 01/01/00 8:46 AM" are at the bottom left. Buttons for "MAIN H", "SAVE", and a red alarm icon are at the bottom right.</p>	<p>6. Enter the 4-digit code for this user. The "User Options" screen is displayed with the user's name and code displayed.</p>
 <p>The screenshot shows the "Ready To Arm" screen. The "User Number" field now contains the code "1963". The "RF Button Zone" field is empty. The name "Tommy" is displayed in a box at the bottom left, and the date and time "Sat 01/01/00 8:46 AM" are at the bottom left. Buttons for "MAIN H", "SAVE", and a red alarm icon are at the bottom right.</p>	<p>7. Select the partitions, access level, and enter a user number for this user.</p> <p>If assigning this user to wireless key, enter one of the zone numbers of the keyfob (the wireless key must be programmed first before it can be assigned to a user).</p>



SCREEN	ACTION
	<p>8. Press the Save button. The system will save the configuration. When the save is complete, the User Setup screen is displayed with the new user's name shown.</p>

How to Delete a User

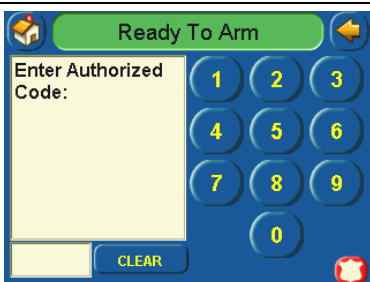
Delete a User as follows:

SCREEN	ACTION
	<p>Three selections are available: add a user, edit a user, or delete a user.</p> <p>1. To delete a user, touch the circle next to the user to be deleted and press the DELETE USER button. The "User Authorization" screen is displayed with the instructions "Enter Authorized Code".</p>
	<p>2. Enter your Authorized code. The Confirm Delete screen is displayed.</p> <p>Note: The authorized code for deleting, adding, and editing users is dependent upon the alarm panel you are interfacing with. Check your alarm panel Installation and Setup Guide to determine who can delete, add, and edit users.</p>

SECTION 5: User Codes

SCREEN	ACTION
	<p>3. Press the appropriate button. The User Setup screen is displayed.</p>
	



How to Edit a User

Edit a User as follows:

Note: You can not edit a User's name. To modify a User name, you must delete the User and re-enter User.

SCREEN	ACTION
	<p>Three selections are available: add a user, edit a user, or delete a user.</p> <p>1. To edit a user, touch the circle next to the user to be edited and press the EDIT USER button. The "User Authorization" screen is displayed with the instructions "Enter Authorized Code".</p>

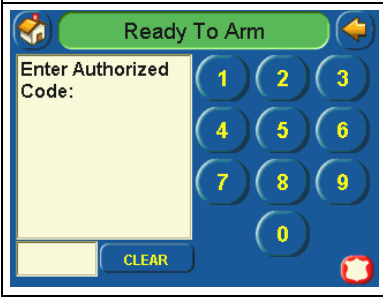
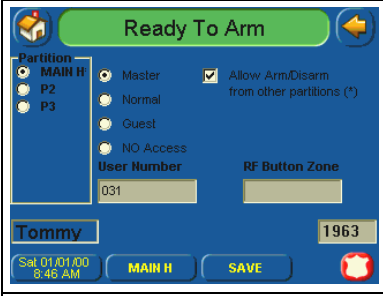
TouchCenter Installation and Setup Guide

SCREEN	ACTION
	<p>2. Enter your Authorized code. The “User Options” screen is displayed.</p> <p>Note: The authorized code for deleting, adding, and editing users is dependent upon the alarm panel you are interfacing with. Check your alarm panel Installation and Setup Guide to determine who can delete, add, and edit users.</p>
	<p>3. Select the options needed for this user and press the Save button. The configuration changes are saved and you are returned to the User Setup screen.</p>
	

Maintenance

.....

In This Section

- ◆ *About TouchCenter Maintenance* ◆ *Routine Care*
 - ◆ *How to Clean the TouchCenter*
-

About TouchCenter Maintenance

With the exception of normal cleaning, the TouchCenter is maintenance free.

How to Clean the TouchCenter

IMPORTANT: Do not use an abrasive cleaning agent or abrasive cloth when cleaning the TouchCenter or damage to the touch screen may occur.





The **Emergency** screen cannot be accessed while running in the clean screen mode.

Clean the TouchCenter as follows:

1. From the "Home" screen, press the **SECURITY** button. The "Arming" screen is displayed.

SCREEN	ACTION
	<ol style="list-style-type: none"> 2. Press the MORE CHOICES button. The "More Choices" screen is displayed.

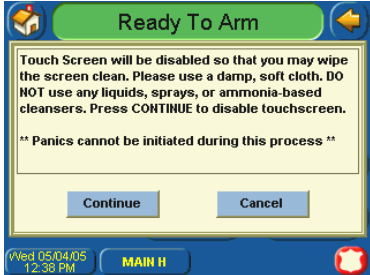
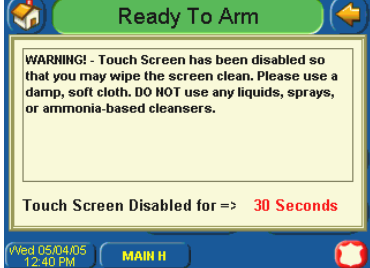
SCREEN	ACTION
 <p>The screenshot shows the 'Ready To Arm' screen with a green header bar. Below the header are several menu items: 'SHOW ZONES', 'CONSOLE MODE', 'EVENT LOGS', 'OPERATING MODES', and 'SETUP'. The 'SETUP' button is highlighted with a white border. At the bottom, there is a status bar showing 'Sat 01/01/00 4:09 AM' and 'MAIN H'.</p>	<p>3. Press the SETUP button on the "More Choices" screen. The "Setup" screen is displayed.</p>
 <p>The screenshot shows the 'Ready To Arm' screen with a green header bar. Below the header are several menu items: 'Backlight Off After' (set to 5 Min), 'To Homepage After' (set to 2 Min), 'USER SETUP', 'CLEAN SCREEN', and 'ADVANCED SETUP'. The 'CLEAN SCREEN' button is highlighted with a white border. At the bottom, there is a status bar showing 'Fri 04/14/00 04:14 AM' and 'MAIN H'.</p>	<p>4. Press the CLEAN SCREEN button. A pop-up window displaying "Touch Screen will be disabled so that you may wipe the screen clean. Please use a damp, soft cloth. DO NOT use any liquids, sprays, or ammonia-based cleansers. Press CONTINUE to disable touchscreen."</p> <p>When the Continue button is pressed the "Touch Screen Disabled for => 30 Seconds". During these 30 seconds the touch screen should be wiped clean of fingerprints using a mild soap solution and a soft cloth. When the counter reaches zero, the window automatically closes and the touch screen is active.</p> <p>Note: Do not spray cleaning agent directly on the screen, spray it on cloth then wipe surface area.</p>
 <p>The screenshot shows the 'Ready To Arm' screen with a green header bar. Below the header is a yellow warning box with the text: 'Touch Screen will be disabled so that you may wipe the screen clean. Please use a damp, soft cloth. DO NOT use any liquids, sprays, or ammonia-based cleansers. Press CONTINUE to disable touchscreen. ** Panics cannot be initiated during this process **'. Below the warning box are 'Continue' and 'Cancel' buttons. At the bottom, there is a status bar showing 'Wed 05/04/05 12:38 PM' and 'MAIN H'.</p>	
 <p>The screenshot shows the 'Ready To Arm' screen with a green header bar. Below the header is a yellow warning box with the text: 'WARNING! - Touch Screen has been disabled so that you may wipe the screen clean. Please use a damp, soft cloth. DO NOT use any liquids, sprays, or ammonia-based cleansers. Touch Screen Disabled for => 30 Seconds'. At the bottom, there is a status bar showing 'Wed 05/04/05 12:40 PM' and 'MAIN H'.</p>	

Routine Care

- Treat the components of the security system as you would any other electrical equipment. Do not slam sensor-protected doors or windows.
- Keep dust from accumulating on the keypad and all protective sensors, particularly on motion sensors and smoke detectors.
- The keypad case and sensors should be carefully dusted with a dry soft cloth. ***Do not spray water or any other fluid on the units.***

Troubleshooting

In This Section









- ◆ *Troubleshooting*
- ◆ *Diagnosics*
- ◆ *Panel Fault Displays*
- ◆ *Performing Diagnostics*

Troubleshooting

For troubleshooting procedures, refer to the Control Panel Installation Guide.

Panel Fault Displays

The “Arming” screen displays an Icon(s) if a panel fault(s) occurs. The fault Icon is displayed to the left of the Panic button. The following Icons may be shown as applicable to your system:

ICON	MEANING
	AC Loss – The system is not receiving AC power.
	Bell Failure – The system bell or siren has a problem. Note: This Icon will be displayed when interfacing with residential panels only.
	Expander Failure – The system has a failure in an expansion module.
	Low Battery – The system battery, that powers the system during an AC power loss, is low.
	LRR Supervision Failure – The Long Range Radio used to communicate with the central station has a supervision failure. Note: This Icon will be displayed when interfacing with residential panels only.
	Pager Failure – The system cannot communicate with an assigned pager.
	Phone Line 1 Failure – The system is not able to communicate with the central monitoring station over the primary phone line.
	Phone Line 2 Failure – The system is not able to communicate with the central monitoring station over the secondary phone line.
	Wireless Failure – The system is not able to communicate with its wireless devices.

Diagnosics



About Diagnosics

A series of diagnostic tests are provided that allows verification of correct operation of the TouchCenter and its connections to the security system. There are a total of three diagnostic tests.



How to Access the Diagnosics

To access diagnosics, do the following:

1. From the "Home" screen, press the SECURITY button. The "Arming" screen is displayed.

SCREEN	ACTION
	<ol style="list-style-type: none"> 2. From the "Arming" screen press the MORE CHOICES button. The "More Choices" screen is displayed.
	<ol style="list-style-type: none"> 3. Press the SETUP button on the "More Choices" screen. The "Setup" screen is displayed.

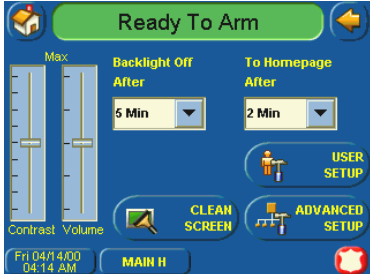
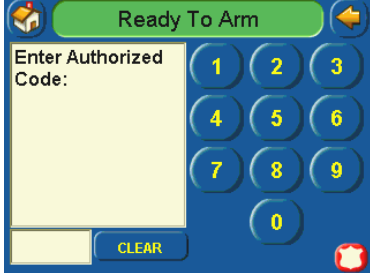
SECTION 7: Troubleshooting

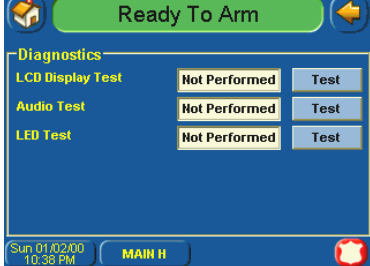
SCREEN	ACTION
 <p>The screenshot shows the 'Ready To Arm' screen with a green header bar. Below the header, there are two vertical sliders for 'Contrast' and 'Volume'. To the right, there are two dropdown menus: 'Backlight Off After' set to '5 Min' and 'To Homepage After' set to '2 Min'. At the bottom, there are buttons for 'USER SETUP', 'CLEAN SCREEN', and 'ADVANCED SETUP'. The status bar at the bottom shows 'Fri 04/14/00 04:14 AM' and 'MAIN H'.</p>	<p>4. Press the Advanced Setup button on the "Setup" screen. The Enter Authorized Code: authorization screen is displayed.</p>
 <p>The screenshot shows the 'Enter Authorized Code' screen. It features a large yellow text box on the left with the text 'Enter Authorized Code:'. To the right is a numeric keypad with buttons for digits 1-9, 0, and a 'CLEAR' button. The status bar at the bottom shows 'Sun 01/02/00 1:27 AM' and 'MAIN H'.</p>	<p>5. Enter your 4-digit Installer code. The "Advanced Setup" menu screen is displayed.</p>
 <p>The screenshot shows the 'Ready To Arm' screen with a green header bar. Below the header, there are four buttons: 'CENTRAL STATION', 'KEYPAD TEST', 'KEYPAD RESET', and 'SOFTWARE VERSION'. The 'SOFTWARE VERSION' button shows '0.0.4 - July 20, 2005'. The status bar at the bottom shows 'Sun 01/02/00 1:27 AM' and 'MAIN H'.</p>	<p>6. Press the Keypad Test button on the "Advanced Setup" menu screen. The "Diagnostics" screen is displayed.</p>
 <p>The screenshot shows the 'Diagnostics' screen. It has a green header bar and a 'Diagnostics' section with three rows: 'LCD Display Test', 'Audio Test', and 'LED Test'. Each row has a 'Not Performed' status and a 'Test' button. The status bar at the bottom shows 'Sun 01/02/00 10:38 PM' and 'MAIN H'.</p>	

Performing Diagnostics

Select any diagnostic test from the Diagnostics screen by pressing its associated **Test** button. All or any individual test may be run when you access the Diagnostics screen; however, each test must be performed one at a time.

At any time when a test is not being performed, you can press:

- the back button to return to the previous screen, or
- the home button to return to your home page.



Once the Diagnostics screen is exited, subsequent entry to this screen displays all test options as "Not Performed."

LCD Display Test

Perform the LCD Display Test as follows:





The **Emergency** screen cannot be accessed while running the LCD Display Test.

SCREEN	ACTION
	<p>When you press the Test button associated with the LCD Display Test, a series of different screens will be displayed. After each type of display, you will be asked if the display was proper. If the response to all questions is yes, the LCD Display Test message area of the Diagnostics screen will display "Passed".</p>

Audio Test

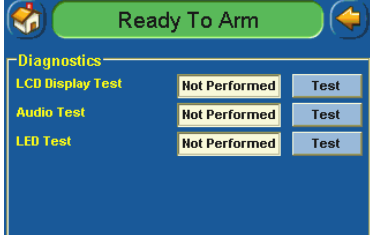
Perform the Audio Test as follows:

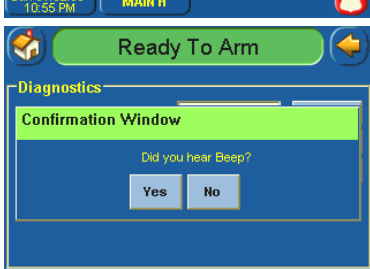
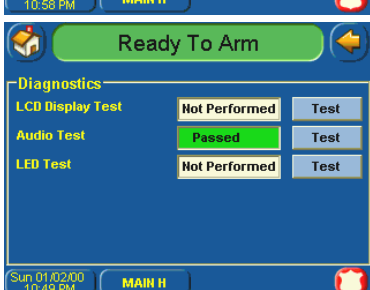
SCREEN	ACTION
	<p>When you press the Test button associated with the Audio Test, "Testing.." is displayed in the test status column on the "Diagnostics" screen while beeps sound from the speaker. At the conclusion of the test, a pop-up "Confirmation Window" is displayed in the center of the "Diagnostics" screen.</p>
	<p>Within the Confirmation Window the question "Did you hear Beep?" is displayed.</p> <p>When you press the Yes button, "Passed" is displayed in the test status column on the "Diagnostics" screen.</p>
	<p>When you press the No button, "Failed." is displayed in the test status column on the "Diagnostics" screen.</p>
	

LED Test

Perform the LED Test as follows:

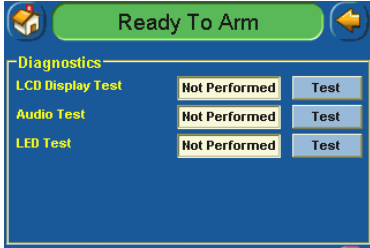
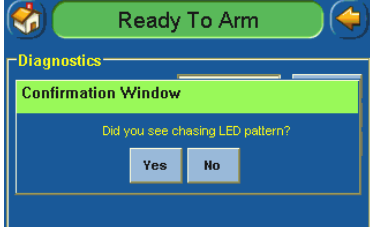
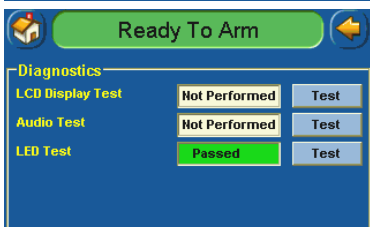
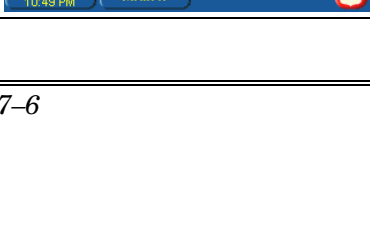
SCREEN	ACTION
	<p>1. When you press the Test button associated with the LED Test, "Testing.." is displayed in the test status column on the "Diagnostics" screen while the 3 LEDs light sequentially, top to bottom (red, green, amber), 5 times. At the conclusion of the test, a pop-up "Confirmation Window" is displayed in the center of the "Diagnostics" screen.</p>
	
	<p>2. Within the Confirmation Window the question "Did you see chasing LED pattern?" is displayed.</p> <p>If you press the Yes button, "Passed" is displayed in the test status column on the "Diagnostics" screen.</p> <p>If you press the No button, "Failed" is displayed in the test status column on the "Diagnostics" screen.</p>
	

Safe Mode

In This Section

- ◆ *About the Safe Mode*
 - ◆ *Operating in the Safe Mode*
 - ◆ *Entering the Safe Mode*
 - ◆ *Exiting the Safe Mode*
-

About the Safe Mode

The TouchCenter contains a Safe Mode of operation. In the rare event that the TouchCenter cannot successfully communicate in its graphic mode with the control panel, the Safe Mode is a backup mode that ensures that you can communicate with your system. In this mode, the TouchCenter operates much like a standard non-graphic keypad so that you can control your system until the problem is corrected.



- DO NOT perform panel programming while in the Safe Mode. Performing panel programming while in the Safe Mode may cause the panel and TouchCenter to become out of sync.
 - DO NOT use several hardwired motion detectors in high traffic locations. The high quantity of signals received by the panel may cause the TouchCenter to enter the Safe Mode.
-

Entering the Safe Mode

The Safe Mode may be automatically entered by the TouchCenter program on a communication failure or may be entered manually on command. The following paragraphs describe these entry processes.

Automatic Entry

In the rare event that the TouchCenter cannot successfully communicate in its graphic mode with the control panel, the TouchCenter presents you with a message of “Problems detected. Start Keypad in Safe Mode?” and requests a “Yes” or “No” response. If you answer with “Yes”, the TouchCenter will go into the Safe Mode. If you answer with “No”, the TouchCenter will try communicating with the panel again. After 3 consecutive times of receiving no response, the TouchCenter will enter the Safe Mode.



Note: Use care when providing the “Yes” or “No” response. Touching the screen outside the prescribed area may cause the background to come to the front. If this occurs, the Yes/No message that disappeared will time out in 30 seconds even though it is not visible. Then the keypad will reset into the Normal Mode (or Safe Mode if this is the third time that the warning message appeared).

Manual Entry



Note: ONLY enter the Safe Mode from the Normal Mode. Entering the Safe Mode from the Demo Mode may result in incorrect display of the Emergency Function keys.



To manually put the TouchCenter into the Safe Mode of operation:

1. From the "Home" screen, press the **SECURITY** button. The "Arming" screen is displayed.

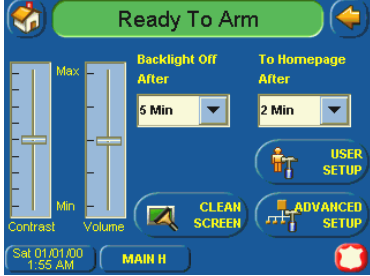
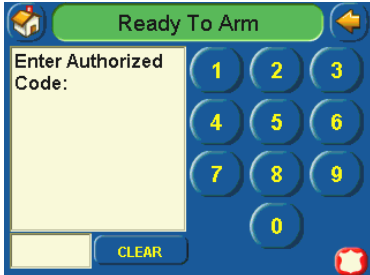
SCREEN	ACTION
	<p>2. Press the MORE CHOICES button. The “More Choices” screen is displayed.</p>
	<p>3. Press the SETUP button on the “More Choices” screen. The “Setup” screen is displayed.</p>

SECTION 8: Safe Mode

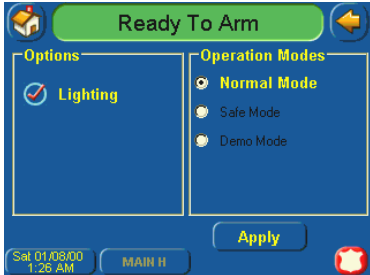
SCREEN	ACTION
	<p>4. Press the ADVANCED SETUP button. The Enter Authorized Code: authorization screen is displayed.</p>
	<p>5. Enter your 4-digit Installer code. The "Advanced Setup" menu screen is displayed.</p>
	<p>6. Press the Central Station button. The "Central Station" menu screen is displayed.</p>
	<p>7. Press the Options button. The "Options" menu screen is displayed.</p>

SCREEN	ACTION
	<p>8. Select Safe Mode and then press the Apply button. The “Warning” message is displayed.</p>
	<p>9. Press the OK button. The TouchCenter will reset and restart in the Safe Mode.</p>

Operating in the Safe Mode

While in the Safe Mode, the Home screen will display the Security button, Panic Button, and a message at the bottom of the screen as shown below:



This is a limited mode of operation. While in this mode:

- You can use the Security button to access the Console Emulation Mode of operation to try to clear your faults, disarm the system, or enter additional Alpha Keypad commands specified in your panel User and Installation Guides. You can perform almost all functions that you can perform from a standard non-graphic alpha keypad.
- You can depress the “Panic” button and generate Emergency Messages as defined in the panels home partition for this TouchCenter.

- The Armed and Ready LEDs on the front of the TouchCenter will indicate the TouchCenter's home partition status. The Message (FA701CVKP) or Trouble (FA701CKP) LED is not active in the Safe Mode.
- The Chime mode will function in the Safe Mode: however, you will not have Voice, Voice Chime, or Message capability if using the FA701CVKP.

Exiting the Safe Mode

To Exit the Safe Mode:

1. Press the ! SAFE MODE ! bar. You will be presented with the following popup message:

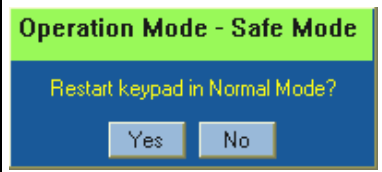
 <p>Operation Mode - Safe Mode Restart keypad in Normal Mode? Yes No</p>	<ol style="list-style-type: none">2. Press the Yes button to return to the Normal Mode of operation. The TouchCenter will reset and restart in the Normal Mode.
---------------------------------------------------------------------------------------------------------------------------------------------------------------------------	--------------------------------------------------------------------------------------------------------------------------------------------------------------------------------------

Specifications

.....

Specifications

MECHANICAL	
Dimensions:	
Width:	7 1/4 inches
Height:	5 inches
Depth:	1 3/8 inches
ELECTRICAL	
Operating Voltage:	+12VDC
Current Drain:	
Backlight OFF, Sound OFF	105mA
Backlight ON, Sound OFF	159mA
Backlight ON, Sound ON	230mA

S E C T I O N 1 0

Index



About the TouchCenter.....	1-1
Address Change	4-3, 4-6
Central Station Screen	
Accessing	4-4
Chime Mode	4-23
Cleaning	6-1
Code Authority	
View.....	4-10
Compatibility	1-2
Contrast Adjustment.....	4-13
Diagnostics	7-2
Audio Test.....	7-5
LCD Display	7-4
LED Test.....	7-6
Performing	7-4
ECP Error	1-2
Front Panel LEDs.....	3-1
Initialization	4-3
Maintenance	6-1
Cleaning.....	6-1
Routine Care.....	6-3
Mounting and Wiring.....	2-1
Night Setup.....	4-8
Operating Modes	
Chime	4-23
Panel Configuration	
Delete	4-12
View.....	4-11
Power Up.....	4-3
Routine Care.....	6-3
Safe Mode	8-1
Screen Security	
Edit	4-9
View.....	4-9

SECTION 8: Safe Mode

Setup	
Contrast	4-13
Specifications	9-1
Electrical	9-1
Mechanical.....	9-1
System Features	1-1
System Options	
Selecting	4-7
Troubleshooting	7-1
Diagnostics	7-2
Performing Diagnostics.....	7-4
User	
Adding	5-4
Deleting	5-6
Editing.....	5-7
User Code Setup	
Access.....	5-2
Voice Mode.....	4-23
Wire Run Length/Gauge	2-2
Word List	4-2

Notes

Notes

Notes

Notes

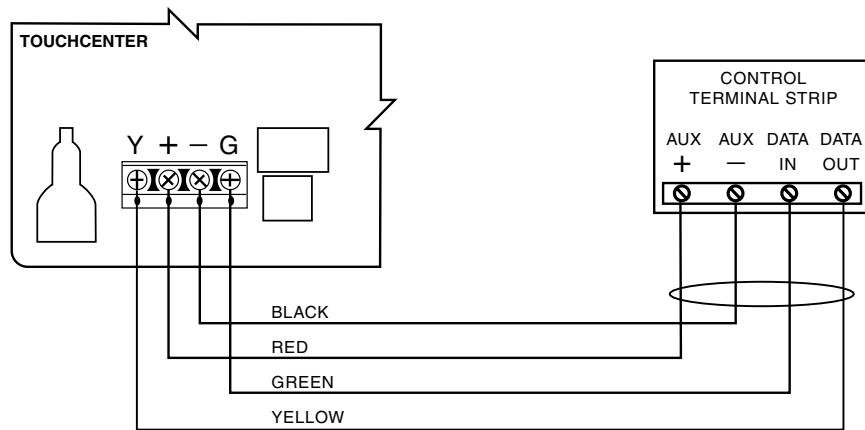

POWERING THE TOUCHCENTER KEYPAD FROM THE CONTROL

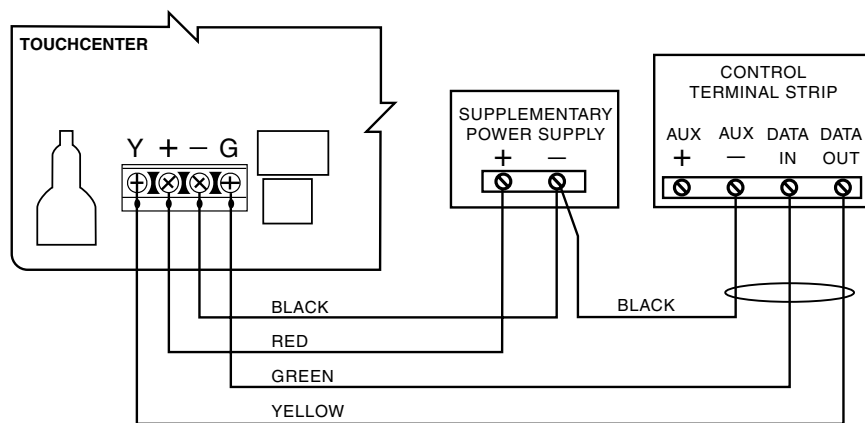

POWERING THE TOUCHCENTER FROM A SUPPLEMENTARY POWER SUPPLY

6271CV-008-V0

UL Use a Listed Class 2 power supply suited for the application.

Summary of Connections

LIMITED WARRANTY

Honeywell International Inc, acting through its First Alert Professional Security Systems business ("Seller"), 2 Corporate Center Drive, Melville, NY 11747, warrants its products to be in conformance with its own plans and specifications and to be free from defects in materials and workmanship under normal use and service for 36 months from the date stamp control on the product or, for products not having a date stamp, for 30 months from date of original purchase unless the installation instructions or catalog sets forth a shorter period, in which case the shorter period shall apply. Seller's obligation shall be limited to repairing or replacing, at its option, free of charge for materials or labor, any product which is proved not in compliance with Seller's specifications or proves defective in materials or workmanship under normal use and service. Seller shall have no obligation under this Limited Warranty or otherwise if the product is altered or improperly repaired or serviced by anyone other than First Alert Professional factory service. For warranty service, return product transportation prepaid, to First Alert Professional Factory Service, 1220 Rojas Deive, Suite 700, El Paso, TX 79936

THERE ARE NO WARRANTIES, EXPRESS OR IMPLIED, OF MERCHANTABILITY, OR FITNESS FOR A PARTICULAR PURPOSE OR OTHERWISE, WHICH EXTEND BEYOND THE DESCRIPTION ON THE FACE HEREOF. IN NO CASE SHALL SELLER BE LIABLE TO ANYONE FOR ANY CONSEQUENTIAL OR INCIDENTAL DAMAGES FOR BREACH OF THIS OR ANY OTHER WARRANTY, EXPRESS OR IMPLIED, OR UPON ANY OTHER BASIS OF LIABILITY WHATSOEVER, EVEN IF THE LOSS OR DAMAGE IS CAUSED BY THE SELLER'S OWN NEGLIGENCE OR FAULT.

Seller does not represent that the products it sells may not be compromised or circumvented; that the products will prevent any personal injury or property loss by burglary, robbery, fire or otherwise; or that the products will in all cases provide adequate warning or protection. Customer understands that a properly installed and maintained alarm may only reduce the risk of a burglary, robbery, fire or other events occurring without providing an alarm, but it is not insurance or a guarantee that such will not occur or that there will be no personal injury or property loss as a result. CONSEQUENTLY, SELLER SHALL HAVE NO LIABILITY FOR ANY PERSONAL INJURY, PROPERTY DAMAGE OR OTHER LOSS BASED ON A CLAIM THE PRODUCT FAILED TO GIVE WARNING. HOWEVER, IF SELLER IS HELD LIABLE, WHETHER DIRECTLY OR INDIRECTLY, FOR ANY LOSS OR DAMAGE ARISING UNDER THIS LIMITED WARRANTY OR OTHERWISE, REGARDLESS OF CAUSE OR ORIGIN, SELLER'S MAXIMUM LIABILITY SHALL NOT IN ANY CASE EXCEED THE PURCHASE PRICE OF THE PRODUCT, WHICH SHALL BE THE COMPLETE AND EXCLUSIVE REMEDY AGAINST SELLER. This warranty replaces any previous warranties and is the only warranty made by Seller on this product. No increase or alteration, written or verbal, of the obligations of this Limited Warranty is authorized.



2 Corporate Center Drive, Melville, Ny 11747

www.firstalertprofessional.com

Copyright © 2007 Honeywell International Inc.



K6248-2V1 6/07 Rev. A